

Basic Characteristics Data

Model	Circuit method	Switching frequency [kHz]	Input current [A]	Rated input fuse	Inrush current protection	PCB/Pattern			Series/Parallel operation availability	
						Material	Single sided	Double sided	Series operation	Parallel operation
ADA600F	Active filter	85	5.9 (Peak 7.0)	250V 12A	SCR	FR-4		Yes	Yes	Yes
	Forward converter	130								
ADA750F	Active filter	85	6.9 (Peak 11.8)	250V 20A	SCR	FR-4		Yes	Yes	Yes
	Forward converter	130								
ADA1000F	Active filter	85	9.5 (Peak 18.2)	250V 25A	SCR	FR-4		Yes	Yes	Yes
	Forward converter	130								

* Refer to Instruction Manual.

* The value of input current is at ACIN 100V and rated load (peak).

1	Function	A-128
1.1	Input voltage range	A-128
1.2	Inrush current limiting	A-128
1.3	Overcurrent protection	A-128
1.4	Peakcurrent protection	A-128
1.5	Thermal protection	A-128
1.6	Overvoltage protection	A-128
1.7	Output voltage adjustment range	A-128
1.8	Isolation	A-128

2	Assembling and Installation Method	A-128
2.1	Installation method	A-128
2.2	Mounting screw	A-128
2.3	Derating	A-129
2.4	Expectancy life and warranty	A-130
2.5	Current monitor	A-130

3	Series Operation and Parallel Operation	A-130
3.1	Series operation	A-130
3.2	Parallel operation/master-slave operation	A-130

4	Peak Loading	A-131
----------	---------------------	-------

5	Option	A-131
----------	---------------	-------

1 Function

1.1 Input voltage range

- The range is from 85 VAC to 264 VAC or 120 VDC to 350 VDC.
Only AC input is available to comply with agency approval.
- AC input voltage must have a range from 85 VAC to 264 VAC for normal operation. If the wrong input is applied, the unit will not operate properly and/or may be damaged.

1.2 Inrush current limiting

- Inrush current limiting is built-in.
- If a switch is being used for input, ensure that it is configured to handle the input inrush current.
- A thyristor is used for protection from inrush current. When turning the power OFF and then ON again within a short period of time, inrush current limiting may be disabled; therefore ensure enough time before switching ON.

1.3 Overcurrent protection

- Overcurrent protection is built-in and comes into effect at over 101% of the peak current in. Overcurrent protection prevents the unit from short circuit and overcurrent condition.
The unit automatically recovers when the fault condition is cleared.

● Intermittent current characteristics

- When the output voltage drops more than 50% of the rated output voltage value at overcurrent, the average output current is reduced by intermittent operation of power supply.

1.4 Peakcurrent protection

- Peakcurrent protection is built-in (The protection circuit operates when load current exceeds the rating current and the use deviates from the condition in Instruction Manual 4).
If this function comes into effect, the output is shut down (delayed shut down).
The minimum interval of AC recycling for recovery is 3 to 4 minutes (*).
*The recovery time varies depending on the voltage and load at the time the protection activated.

1.5 Thermal protection

- Thermal protection circuit is built-in and shut down under following condition.
 - ① When the current and the temperature which exceed from the derating curve.
 - ② The case FAN stops or air flow is interrupted and the amount of the wind decreases.
 If the thermal protection activates, shut off input voltage, remove the cause of the overheating, wait for the unit to cool down, and recycle to recover output voltage.

1.6 Overvoltage protection

- Overvoltage protection is built in. When the overvoltage protection activates, shut off input, wait for at least 3 to 4 minutes, and recycle to recover output voltage(*).
*The recovery time varies depending on input voltage.

Remarks : Please avoid applying the over-rated voltage to the output terminal. Power supply may operate incorrectly or fail. In case of operating a motor etc. , please install an external diode on the output terminal to protect the unit.

1.7 Output voltage adjustment range

- Adjustment of output voltage is possible by using potentiometer.
- Output voltage is increased by turning potentiometer clockwise and is decreased by turning potentiometer counterclockwise.

1.8 Isolation

- For a receiving inspection, such as Hi-Pot test gradually increase (decrease) the voltage for the start (shut down).
Avoid using Hi-Pot tester with the timer because it may generate voltage a few times higher than the applied voltage, at ON/OFF of a timer.
If the unit is tested on the isolation between input & output and output & FG, remote ON/OFF (option) must be shorted to outputs.

2 Assembling and Installation Method

2.1 Installation method

- When two or more power supplies are used side by side, position them with proper intervals to allow enough air ventilation. Ambient temperature around each power supply should not exceed the temperature range shown in derating curve.
- Fix firmly, considering weight, though it can be used by the installation method shown in Fig.2.2.

2.2 Mounting screw

- The screw should be inserted up to 6mm max from outside of the power supply to keep a distance between inside parts and an isolation (Fig.2.1).

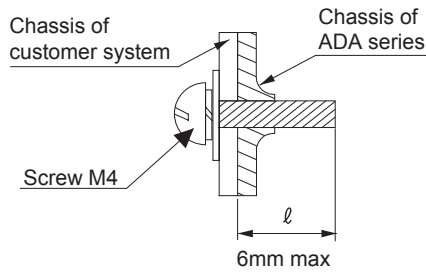

Fig.2.1 Mounting screw

2.3 Derating

Derating by ambient temperature

Load factor 100% in each derating curve means rating current in Specifications. Please note load factor 100% depends on input voltage and cooling method.

In the hatched area the specification of Ripple, Ripple Noise is different from other area.

Convection cooling

- ① Install the unit to apply enough convection as shown in Fig.2.2.
- ② Do not block the ventilation hole.

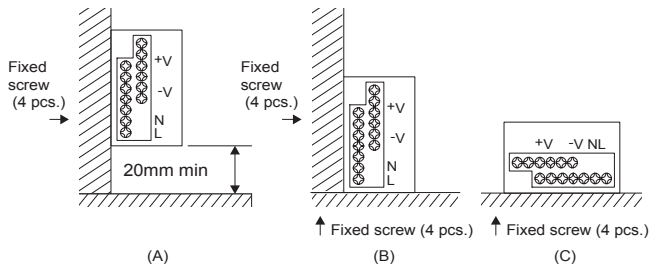
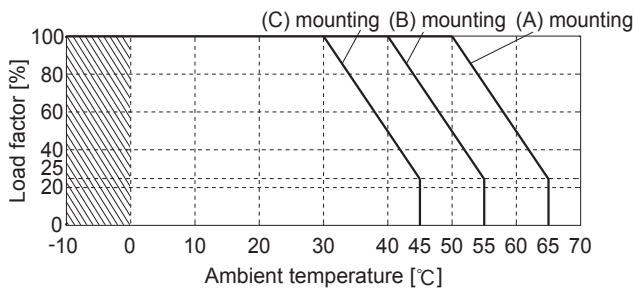

Fig.2.2 Installation method

ADA600F (convection cooling)



*In case of ADA600F-24, load factor 100% means output 24V, 14A at ACIN100V, 24V, 15A at ACIN200V.

ADA750F (convection cooling)

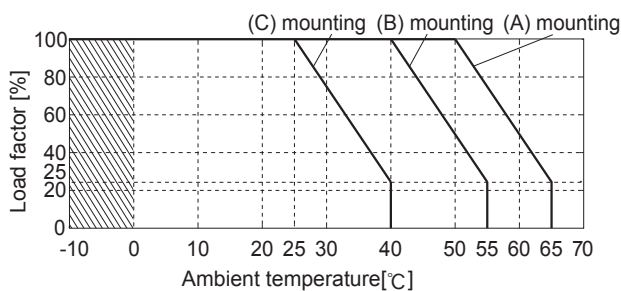

*In case of ADA750F-24, load factor 100% means output 24V, 17A at ACIN100V, 24V, 19A at ACIN200V.

ADA1000F (convection cooling)

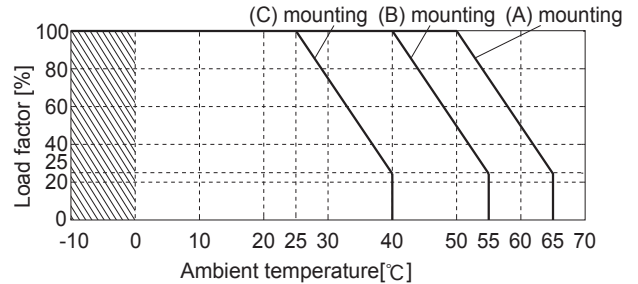

*In case of ADA1000F-24, load factor 100% means output 24V, 21A at ACIN100V, 24V, 25A at ACIN200V.

Forced air cooling

- ① Please give the entire power supply in ventilation so that the temperature of point A and B in Fig.2.3 is made below a specified temperature. Point A and B are displayed in chassis.
 - Point A 60°C or less and point B 65°C or less at Ta = 50°C
 - Point A 80°C or less and point B 80°C or less at Ta = 71°C

Remarks : Please avoid cooling only bottom chassis.

- ② Ventilation is done evenly and do not block the ventilation hole.
 - ③ The confirmation of point A and B is unnecessary when optional fan unit is used. Refer to 5.Option (only output 24V).
- *The derating curve at forced air is common in ADA600F to ADA1000F.

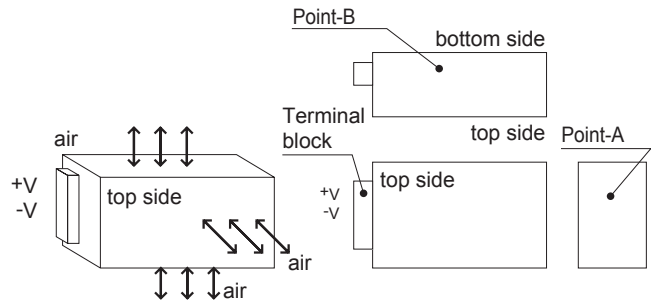
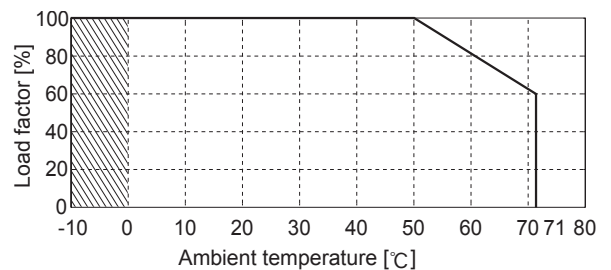

Fig.2.3 Forced air cooling

ADA600F - ADA1000F (forced air)



*In case of ADA600F-24, load factor 100% means output 24V, 21A at ACIN100V, 24V, 25A at ACIN200V.

*In case of ADA750F-24, load factor 100% means output 24V, 25A at ACIN100V, 24V, 31.5A at ACIN200V.

*In case of ADA1000F-24, load factor 100% means output 24V, 33A at ACIN100V, 24V, 42A at ACIN200V.

ADA

2.4 Expectancy life and warranty

■ Expectancy life

The expectancy life is as follows. The mean of load factor 100% depends on installation condition, refer to SPECIFICATION.

Installation condition	Average ambient temperature (year)	Load factor	
		50%	100%
Convection * (Installation A)	Ta = 30°C	More than 10 years	More than 10 years
	Ta = 40°C	More than 10 years	6 years
	Ta = 50°C	5 years	3 years
Forced air *	Ta = 30°C	More than 10 years	More than 10 years
	Ta = 40°C	More than 10 years	6 years
	Ta = 50°C	5 years	3 years

*Refer to 2.3 Derating

■ Warranty

The warranty is 5 years when average ambient temperature of year is Ta = 40°C or less and load factor is average 50% or less. However, the warranty is 3 years when average ambient temperature of year is Ta = 50°C or less and load factor is series 100%.

2.5 Current monitor

■ It is possible to monitor load current by measuring CB voltage that is between CB terminal and -V terminal. The relation between CB voltage and load current is shown in Figs.2.4 to 2.6.

Note : Figs.2.4 to 2.6 are references, and are not meant to be taken as guaranteed values.

■ Ensure that voltage measurement between CB and V terminals is carried out with equipment that has sufficient input impedance (testers, etc.). If this equipment has low input impedance, then the relationship between CB voltage and output current will change. Additionally, please be aware that a short between terminals may result in damage to internal components.

■ Please use twist pair cable or shield cable between CB terminal and -V terminal, or the operation may be malfunction.

■ Please use an oscilloscope for pulse loads.

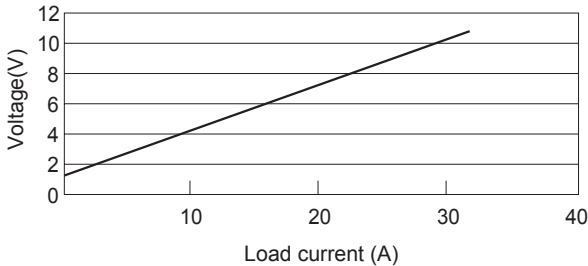

Fig.2.4 Load current conversion graph (ADA600F-24)

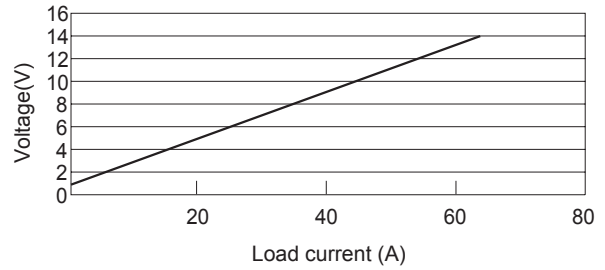

Fig.2.5 Load current conversion graph (ADA750F-24)

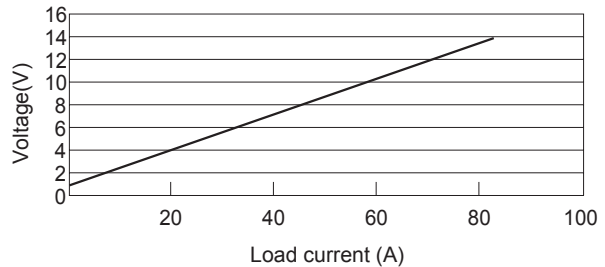

Fig.2.6 Load current conversion graph (ADA1000F-24)

3 Series Operation and Parallel Operation

3.1 Series operation

■ Series operation is available by connecting the outputs of two or more power supplies with the same output voltage, as shown below. Output current in series connection should be lower than the lowest rated current in each unit.

■ Parallel operation is show in Fig.3.1.

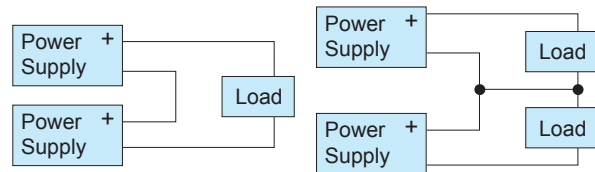

Fig.3.1 Examples of series operation

3.2 Parallel operation/master-slave operation

■ Parallel operation is available by connecting below.

■ As variance of output current drew from each power supply is maximum 10%, the total output current must not exceed the value determined by the following equation.

$$\left[\text{Output current in parallel operation} \right] = \left[\frac{\text{The rated current per unit}}{\text{current per unit}} \right] \times (\text{Number of unit}) \times 0.9$$

When the number of units in parallel operation increases, input current increases at the same time. Adequate wiring design for input circuitry is required, such as circuit pattern, wiring and current capacity for equipment.

In parallel operation, the maximum operative number of units is 5.

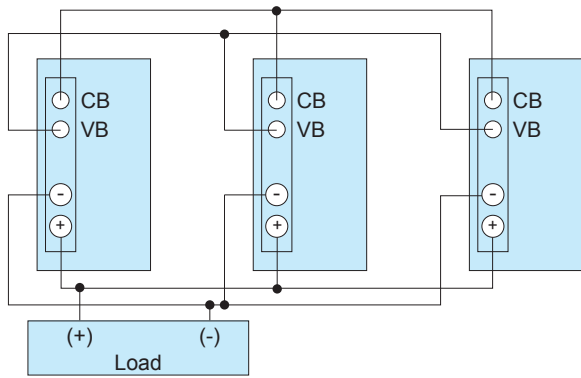

- Output voltage in parallel operation is adjustable by using the potentiometer of the "master" unit. Select one power supply to be the master, and turn the potentiometer of the other, "slave" power supplies, clockwise to the end. Then use the potentiometer of the master to adjust output voltage.
- When the output current is less than 5 to 9% of rated output current (ACIN200V at forced air), the output voltage fluctuates occasionally. The minimum current is different depend on the model and the number of parallel operation, so please consult us at any-time.
- In parallel operation, output voltage increases like stairs due to a delay of the rise time of output voltage at turn on.

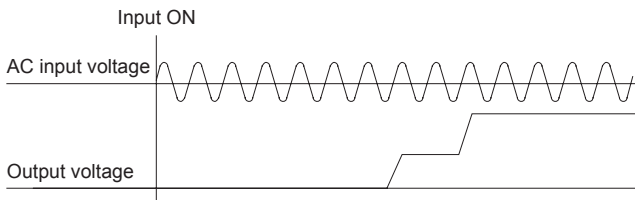
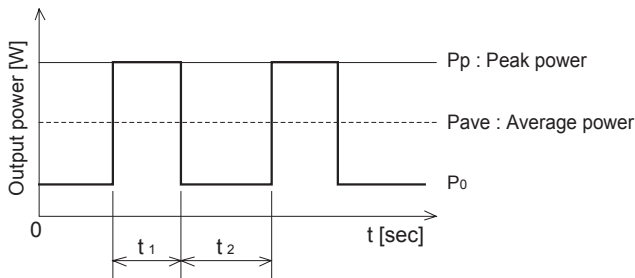

Fig.3.2 Start-up wave form in series and/or parallel operation

4 Peak Loading

- Peak load is possible to draw as below.
- Ensure that the device is used in accordance with the following conditions, as failure to do so may result in damage to internal components.
- Due to the nature of a pulse load, a power supply may make a sound (noise). If the unit is used in a quiet place, consult factory for the load condition in advance.



$$t_1 \leq 10 \text{ [second]}, P_{ave} = \frac{P_{p1} + P_{p2}}{t_1 + t_2} \leq \text{rated power}$$

$$\text{Duty} = \frac{t_1}{t_1 + t_2} \leq 0.35 \text{ (Refer to below chart)}$$

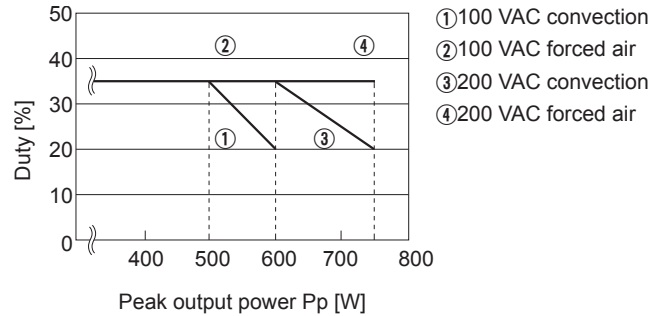

Fig.4.1 Relation between Peak power and Duty (ADA600F)

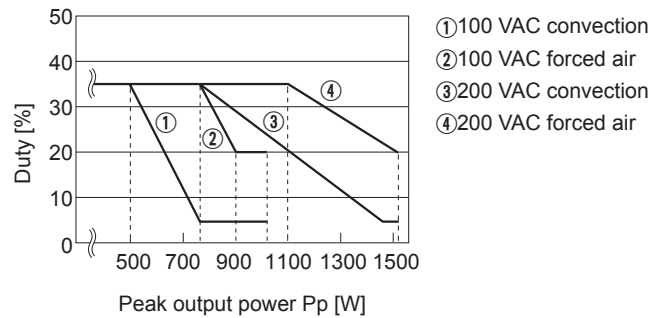

Fig.4.2 Relation between Peak power and Duty (ADA750F)

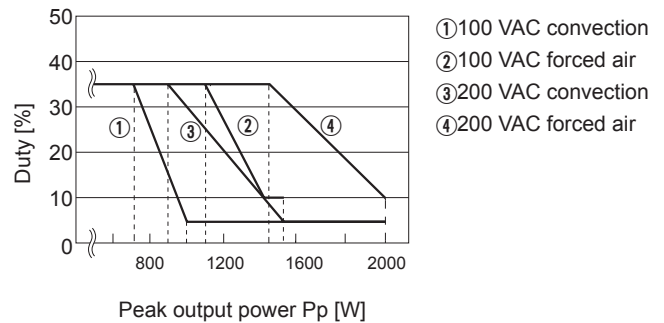

Fig.4.3 Relation between Peak power and Duty (ADA1000F)

5 Option

5.1 Option outline

- Consult us detailed option and delivery before hand.
- While some combinations of options are possible, some combinations are not. Please consult us for details.

● -E, -G

- Low leakage current type.
- The difference from standard is shown Table 5.1.

Table.5.1 Low leakage type

	-E	-G
Leakage current (230 VAC)	0.5mA max	0.15mA max
Conducted Noise	Class A	Not available
Ripple Noise	1.5 times standard	2.0 times standard

- F (Only 24V is prepared. It is not possible combine with option -J)
 - Option -F means fan unit is attached to standard model.
 - Power for the fan unit is supplied from the main unit; therefore fan ripple voltage may appear in the output voltage.
 - Consult us external view in detail.
 - Regular maintenance is required for fan unit. Consult us life expectancy of fan.

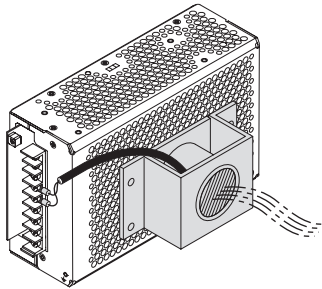

Fig. 5.1 Option -F

- T
 - -T means terminal block is changed from horizontal to vertical position.
 - Please be aware that the number of pins for output terminals differs from standard products.
 - Consult us external view in details.

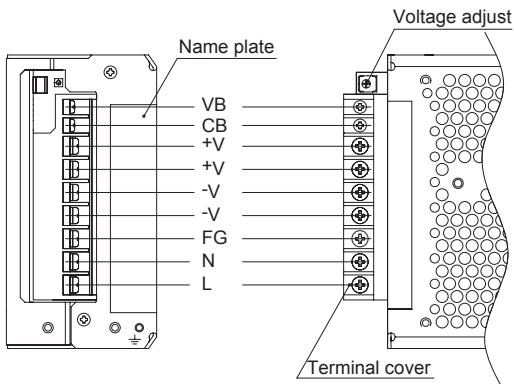
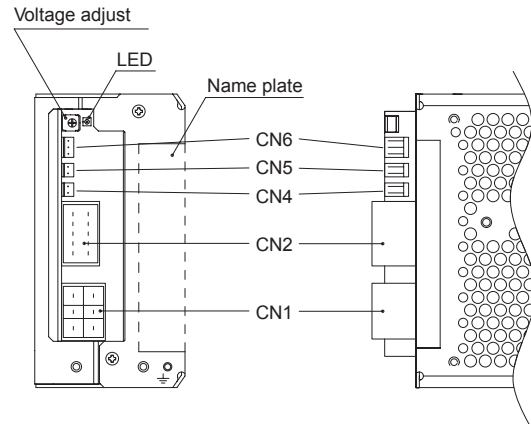

Fig.5.2 Part around terminal block (-T)

- J (Combinations with -W and -F are not possible)
 - -J means terminal block is changed to connector.
 - Special harness is prepared. Refer to option parts.
 - Consult us external view in details.



CN1 does not have a FG terminal; therefore, when connecting a power supply, connect the \perp mark on the cover to the chassis earth.

Fig. 5.3 Option -J

CN1			CN2		
Pin No.	Input		Pin No.	Output	
A	1	N	1	+V	
	2	NC	2	+V	
	3	L	3	-V	
B	1	N	4	-V	
	2	NC	5	-V	
	3	L	1	+V	

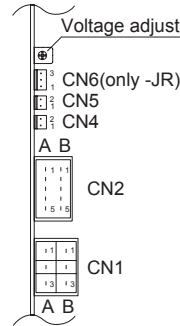

Mating connector(terminal)
Mfr : AMP
1-178129-6
(1-353717-5 equivalent goods)

Mating connector(terminal)
Mfr : AMP
178289-5
(1-353717-5 equivalent goods)
*Keep drawing current per pin below 8.5A

CN4,5			CN6(only -JR)		
Pin No.	Signal		Pin No.	Remote ON/OFF	
1	CB		1	RC-	
2	VB		2	NC	
			3	RC+	

Mating connector(terminal)
Mfr : AMP
171822-2
(170205-2 equivalent goods)

Mating connector(terminal)
Mfr : AMP
171822-3
(170205-2 equivalent goods)

- C
 - -C means internal PCB is coated. (Improved moisture resistance)

- R
 - Option "-R" is available for remote ON/OFF.

Between RC (+) and RC (-)	Output
SW ON (4.5 - 12.5V)	ON
SW OFF (0 - 0.5V)	OFF

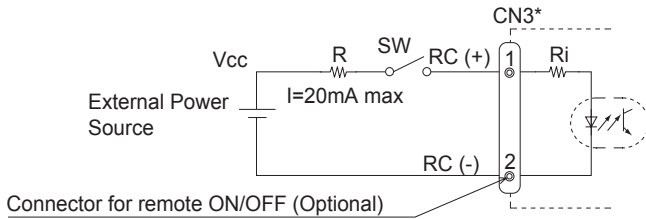

Fig.5.4 Example of use remote ON/OFF

*This connector is different if used with option -J. Refer to Fig. 5.3 for pin arrangements.

■When external power source is in the range of 4.5 - 12.5V, current limit resistance R is not required. However, when external power source exceeds 12.5V, current limit resistance R must be connected.

To calculate the current limit resistance, use the following equation:

$$R [\Omega] = \frac{V_{cc} - (1.1 + R_i \times 0.005)}{0.005}$$

Where ;

V_{cc} = External Power Source

R_i = The internal resistance (780Ω)

■A wrong connection may damage the internal components of the unit.

■Remote ON/OFF circuit (RC (+), RC (-)) is isolated from input, output and FG.

●-N1

- A type with a fitting supporting a dedicated DIN rail.
- Consult us external view in details.
- A type in which terminal block screws are aligned vertically (option: -T).

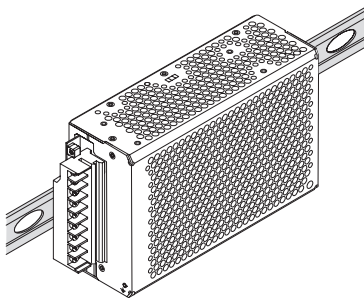

Fig. 5.5 Din Rail Attachment

●-W (It is not possible to combine with option -J)

- -W is available for detecting low input alarm (PF), detecting low output voltage (LV) and operating N+1 redundancy.
- Alarm specification is shown Table 5.2.
- Special harness is prepared, refer to option parts.
- Consult us external view in details.
- Each alarm (PF, LV) is isolated from input, output and FG.

Table 5.2 Explanation of alarms

	Alarm	Output of alarm
PF	When line voltage is abnormal (low input voltage out of range), the alarm outputs from CN3.	Open collector method Good : Low (0 - 0.8V, 1mA max) Fail : 50V max
LV	If the output voltage drops below the rating, the alarm signal is output from CN3. Note : ①This becomes unstable in the event of output overcurrent (intermittent overcurrent). ②The alarm signal is not output for parallel operation that does not use OR diodes.	Open collector method Good : Low (0 - 0.8V, 1mA max) Fail : 50V max

Please consult us details.

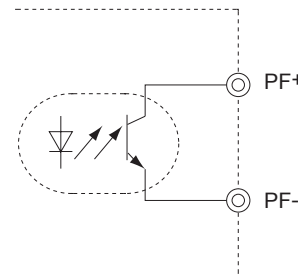

Fig.5.6 PF internal circuit

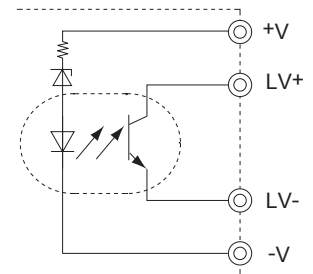

Fig.5.7 LV internal circuit

ADA

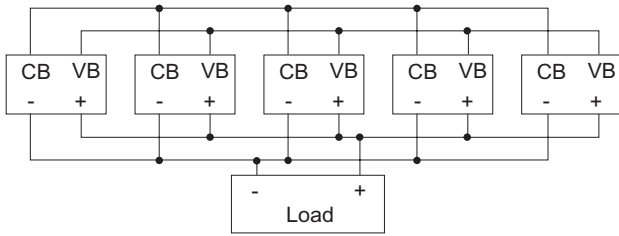

Fig.5.8 N+1 redundant operation

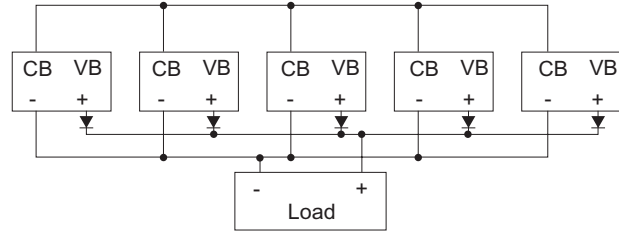

Fig.5.9 N+1 redundant operation which uses diode

■ In the event of one power supply failing and ceasing output of power, use of N+1 parallel redundancy means that output voltage is guaranteed through a backup; therefore, the system can continue with normal operation.

However, please consider the following condition.

- ① 5% or less of the output voltage decrease when one power supply stops.
- ② Even if one or several power supplies stop, output current that meets the following formula is required from the remaining normally operating power supplies.

$$\left[\text{Output current in parallel operation} \right] \leq \left[\frac{\text{The rated current per unit}}{\text{Number of unit}} \right] \times (\text{Number of unit}) \times 0.9$$

In parallel operation, the maximum operative number of units is 5.

- ③ Please detach or exchange the broke down power supply after intercepting the input voltage (impossible hot swap).
- ④ The broke down power supply is detached or exchanged, and after output voltage of new one is adjusted alone, the power supply should be connected load (your system).

* Parallel operation cannot be done with standard model.

· The following electric specifications are different from standard model.

Output Voltage(V)		24	30	36	48
ADA600F	Load Regulation (mV)	240 max	300 max	360 max	480 max
ADA750F					
ADA1000F					

- ⑤ If diodes are used to configure a circuit to achieve even higher reliability, use connections as in Fig. 5.9.
 - Please connect the diode with +V.
 - Please do not connect VB of the power supply mutually. In this case, master-slave operation cannot be done.
 - Please adjust to become 100mV or less the difference of setting VB voltage of each power supply by the potentiometer for the output voltage setting to suppress the change of the output voltage to about 5% or less when one stops.